

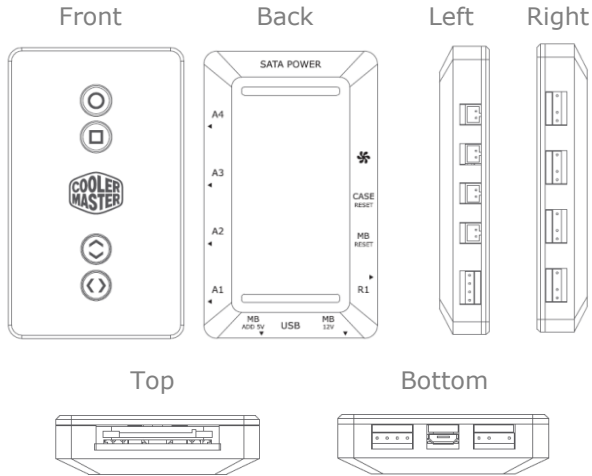

# USER MANUAL

## 01. Controller Description



## 02. LED Modes

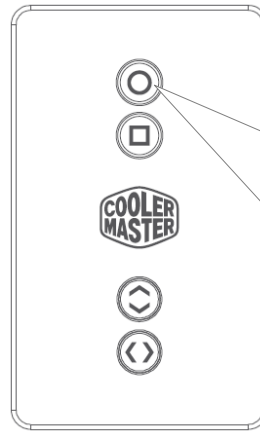

- Press:**
1. Spectrum Cycle
  2. Single Slide Mode
  3. Double Slide Mode
  4. Breathe Mode
  5. Accumulate Mode
  6. Demo Mode
  7. Turn Off
  8. Testing Mode(Reserved)

## 03. Addressable RGB/RGB Mode

**IMPORTANT: 7 LEDs indicators are illuminated for illustration purposes. The lights will not be visible when the device is turned off.**

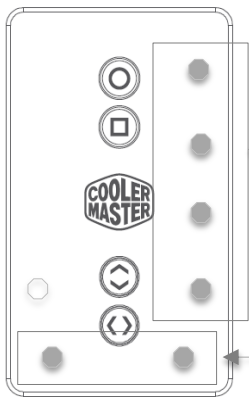

- Default:**  
When plugged in on right side 4 LED will light up. For demonstration purpose the LED light will be shaded to indicate that it is on
- Note:**  
The 2 bottom LED always on when plugged in.

## 04. Addressable RGB/RGB Mode

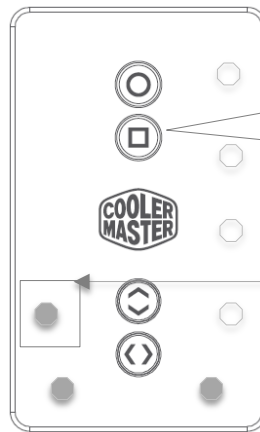

**Press Once:**  
To Switch to standard RGB Mode

**Note:**  
After switching to RGB Mode, the 1 right side LED will light up

## 05. Addressable RGB/RGB Mode

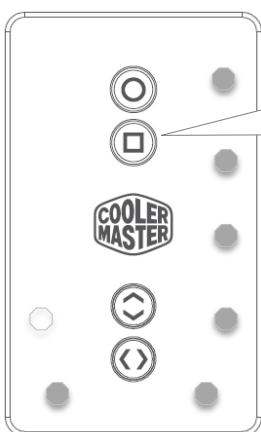

**Press Again:**  
To switch back to Addressable RGB mode

## 06. Color Adjustment Mode

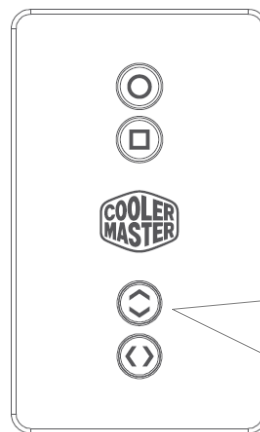

**Press:**  
To switch colors in LED mode

**NOTE:**  
In LED mode 1 and 6 this is not applicable as it is a multi-color function.



# USER MANUAL

## 07. Lighting Speed Adjustment

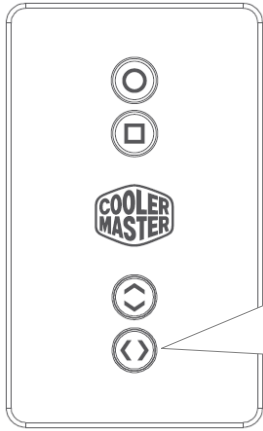

### Press

1. Slowest
2. Slow
3. Medium
4. Fast
5. Fastest

## 08. Left Side Functions

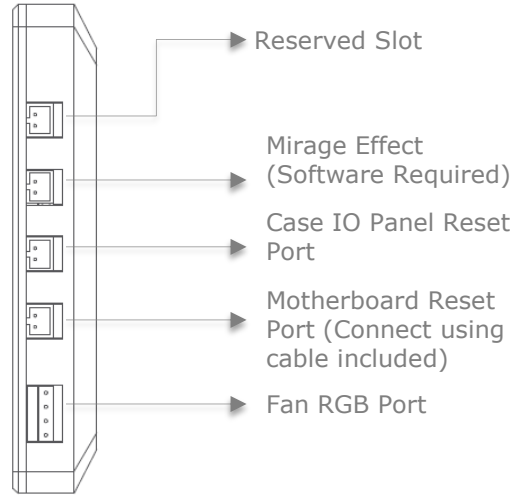

## 09. Reset Function (Plugged in)

**When Plugged in:**  
The Reset Button on the Case IO Panel can be used to switch between LED modes, (same as in Step 2). Press and Hold for 5 secs to restart your computer

## 10. Right Side Function

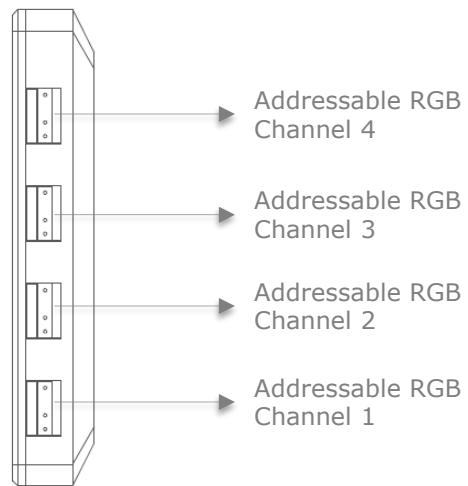

## 11. Top Function

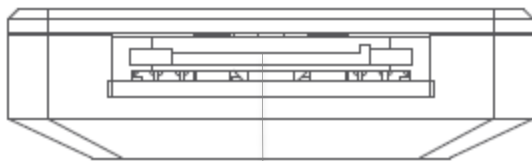

SATA Power Port

## 12. Bottom Functions

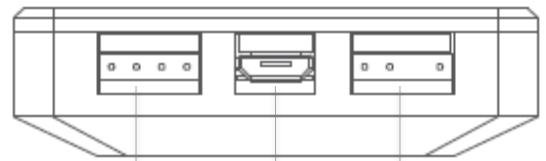

RGB Motherboard Port

USB Software Port

Addressable RGB Motherboard Port